

Powertite™ Series Pin and Sleeve Plugs, Connectors and Receptacles

NEC/CEC:

Listed for Ordinary (Unclassified) Locations
NEMA 3, 4, 4X

PLUGS AND RECEPTACLES: NEC/CEC ORDINARY LOCATION

APPLETON™

Applications

- Designed to supply power to portable or fixed electrical equipment such as motor generator units, welders, pumps, compressors, cellular relay stations, SCR/VFD houses, and similar equipment.
- Ideal for use in "ship to shore" and backup/temporary power applications.
- Suitable for use in locations where a weatherproof enclosure is required.
- Rough usage construction.

Features

- Available in 30, 60, 100, 150, 200, and 400 Amp units.
- Available in two grounding styles: Style 1 (shell only) and Style 2 (shell and extra pole).
- Neoprene bushing compressed by cable collar prevents entrance of water. Bushing is highly resistant to hydrocarbon deterioration and is self-extinguishing.
- Locking screw and slot prevents plug cable collar from "backing off."
- Contacts exert constant pressure along entire contact surface and provide electrical continuity.
- Ambient temperature range of -25 °C to +40 °C (-13 °F to +104 °F).
- Insulating blocks provide greatest dielectric and mechanical strength and lowest arc tracking.
- Positive polarization: only plugs and receptacles of same style, number of poles and ampere rating can be used together.
- Circuit breaking: in 30, 60, 100, 150 and 200 Amp units, any arcing created as line and load terminals disengage is safely confined deep within terminal cavities. Plugs may be withdrawn in an emergency under full rated loads without separate disconnect switches (400 Amp plug is for disconnecting use only; not for current rupturing).
- 30, 60, 100, and 150 Amp Powertite™ plugs also suitable for classified locations when used with Appleton EBR, EBRH, JBR, MD2SR, or DBR explosionproof interlocking receptacles.
- Controlled length contacts ensure that ground makes first and breaks last for added safety.
- Intermatability ①: Intermateable with Crouse-Hinds † Arktite® and Powermate™, and Killark ‡ Versamate®.

Standard Materials

- Plug, receptacle, connector and mounting box housings: copperfree (4/10 of 1% max.) aluminum
- Insulating blocks: glass filled polyester

Standard Finishes

- Aluminum plug, receptacle, connector and mounting box housings: epoxy powder coat
- Insulating blocks and contacts: natural finish



30 and 60 Amp



100 and 150 Amp



200 Amp

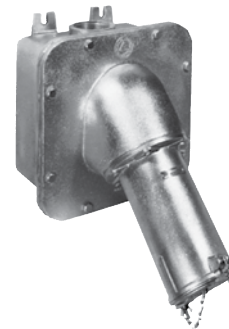

400 Amp

Options

- See Illustrated Options section for details.
- Standard Service, Reverse Service (Generator Application), and Special Polarization.
- Lock Collar accessory to secure plug and connector connections from unauthorized intentional disconnection.
- NEMA 4X Cap accessory for plugs to protect insulation and plug contacts from moisture, dirt, dust and corrosion when not in use.

NEC/CEC Certifications and Compliances

- UL Standard: UL 1682, UL 1686, UL 50E
- UL Listed: E145916, E145917
- cULus Listed: E145917 (200 Amp)
- CSA Standard: C22.2 No. 182.1-13
- CSA Certified: 065179
- NEMA 4X (30, 60, 100, 150, and 200 Amp)
- NEMA Configuration: FB11

Related Products

- For classified location plugs and receptacles, see *Plugs and Receptacles: Hazardous Location*.

① Appleton Powertite series 30 through 100 Amps is UL Classified for use in specific combinations with Crouse-Hinds Arktite®.

† Arktite is a registered trademark of Cooper Crouse-Hinds.

‡ Versamate is a registered trademark of Hubbell Killark.

Powerlite™ Series Pin and Sleeve Plugs, Connectors and Receptacles

NEC/CEC:
Listed for Ordinary (Unclassified) Locations
NEMA 3, 4, 4X

Illustrated Features

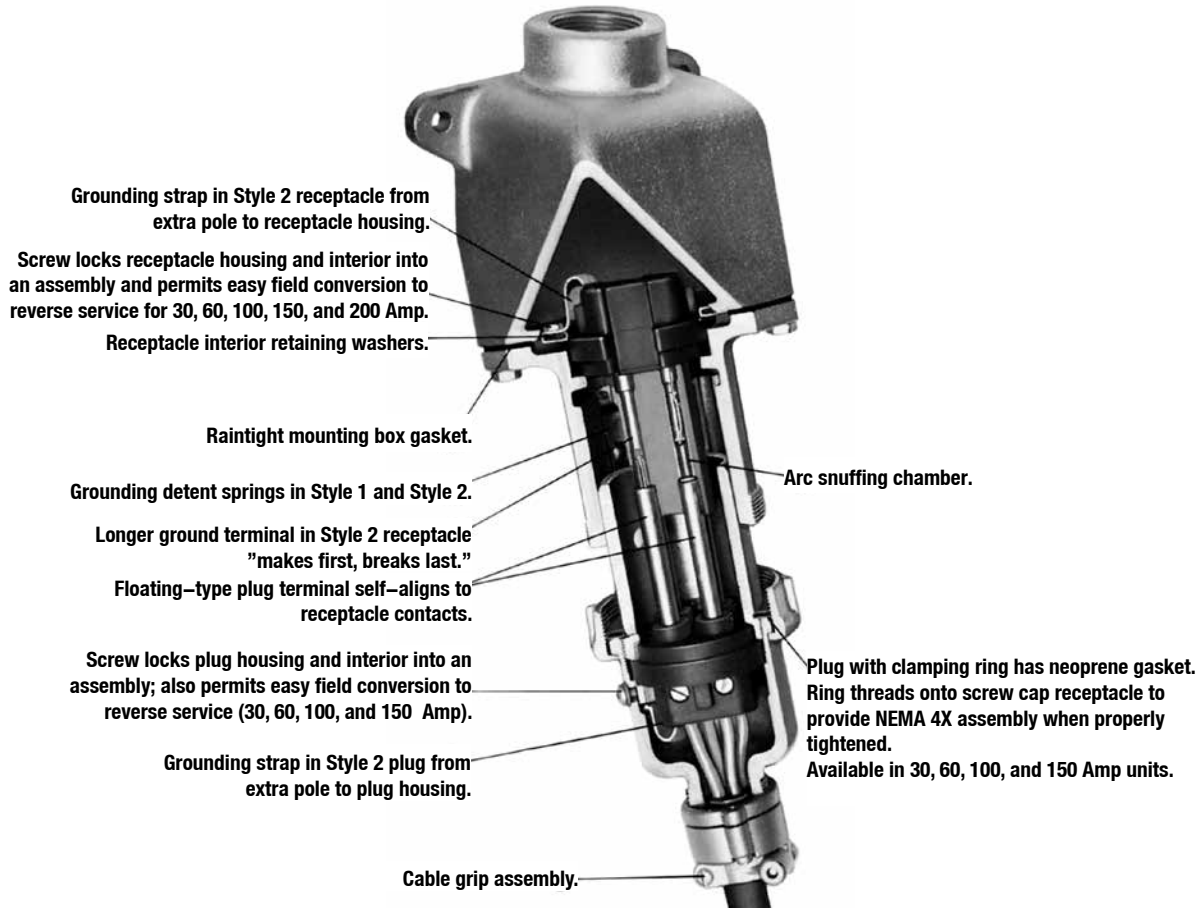

PLUGS AND RECEPTACLES: NEC/CEC ORDINARY LOCATION

APPLETON™

Powertite™ Series Pin and Sleeve Plugs, Connectors and Receptacles

NEC/CEC:
Listed for Ordinary (Unclassified) Locations
NEMA 3, 4, 4X

PLUGS AND RECEPTACLES: NEC/CEC ORDINARY LOCATION

APPLETON™

Illustrated Features

Grounding Styles

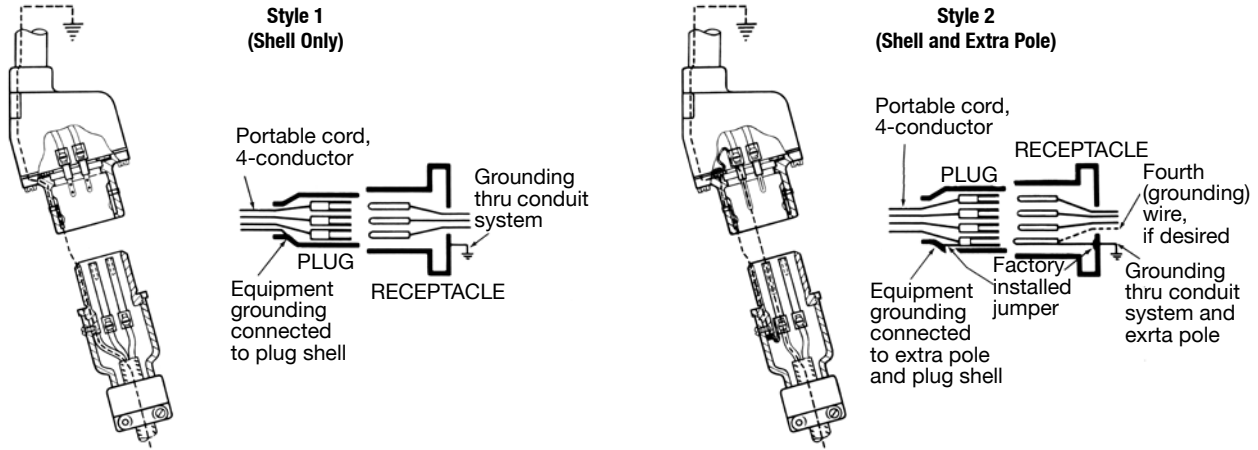

Plug—Equipment grounding conductor is wired directly to solderless lug which is connected to the plug housing with a pressure connector. All terminals are "current carrying."

Receptacle—Two detent spring clips engage the grounded plug housing on plug insertion-grounded plug shell makes contact with receptacle ground spring before line and load poles are engaged. Grounding path is maintained until after current-carrying contacts disengage. All terminals are "current carrying."

Plug—Equipment grounding conductor is not only connected to the solderless lug in the plug housing, but also to an extra grounding pole. Grounding pole has copper alloy grounding jumper strap that connects to plug housing.

Receptacle—Two detent spring clips engage grounded plug housing on plug insertion. Jumper from extra grounding pole is electrically connected to a screw on receptacle housing. Longer grounding pole "makes first and breaks last."

Pin and Sleeve Design ①



30, 60, and 100 Amp Pressure Wire Terminals.
Solid Brass Contacts with Beryllium Copper Springs.

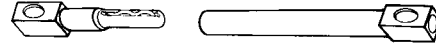

150 Amp Pressure Wire Terminals.
Solid Copper Contacts with Beryllium Copper Springs.

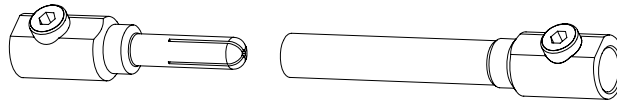

200 Amp Pressure Wire Terminals. Solid Copper Split-Type Contact.

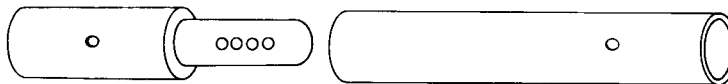

400 Amp 0.84" Solder Well Wire Terminals. Solid Copper Contacts with Four Spring-Loaded Borosilicate Bearings.

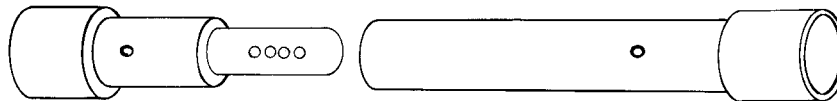

400 Amp 1.25" Solder Wire Well Terminals. Solid Copper Contacts with Four Spring-Loaded Borosilicate Bearings.

① Pins and sleeves are not sold separately. Must be purchased as entire interior replacement. Available on the Replacement Interiors pages.

PowerTite™ Series Pin and Sleeve Plugs, Connectors and Receptacles

NEC/CEC:
Listed for Ordinary (Unclassified) Locations
NEMA 3, 4, 4X

Illustrated Features

Spring Door and Screw Cap

30, 60, 100, and 150 Amp spring door and screw cap receptacles are threaded to accept clamping ring ACP plug. The ring threads onto the receptacle to form a raintight assembly with plug in use-and also to prevent plug fallout. When the plug is withdrawn, the gasketed spring door cover closes tightly against receptacle opening automatically, providing weatherproof protection. Spring door has stainless steel spring and shaft.

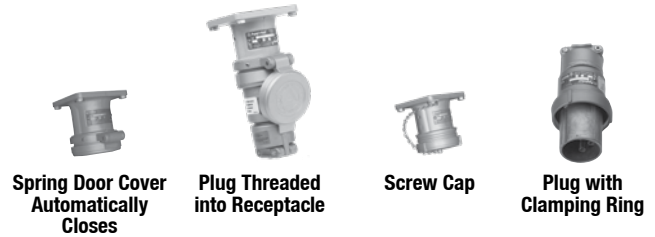

Spring Door Cover

30, 60, 100, and 150 Amp units may be located at any position in a 360° circle by adjusting a setscrew. Set screw also allows complete removal of cover. Spring door available on 200 Amp units.
NOTE: Spring Door cover in open positions for illustration only.



ACP Plugs

Supplied with bushings to accommodate a wide variety of cable diameters.



Reversible Cable Clamps

Permits wide cable range (just loosen screws and flip over). Each position accommodates one of two bushings. Convenient in installations having different cable sizes.



Illustrated Options

Standard Service

Energized receptacle has recessed male contacts to reduce danger of accidental touching. Plug has female contacts that are energized only upon insertion in receptacle.

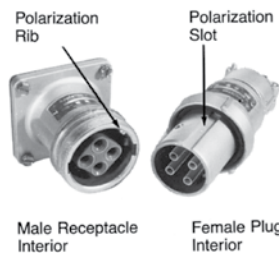

Reverse Service (Generator Application)

Useful where a "hot" plug feeds a dead receptacle. Reverse service is often used for generator applications where the receptacle houses a dead plug interior. Plug houses an energized receptacle interior, which has recessed male contacts to reduce danger of accidental touching. 30, 60, 100, 150, and 200 Amp units can be easily converted to reverse service in the field when matching plug and receptacle are ordered. 400 Amp unit is only available as a factory assembled item at extra cost. Add suffix **-RS** to receptacle or connector.

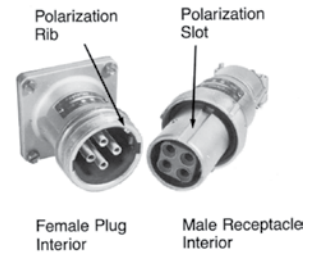

Special Polarization

Special polarization is available on 30, 60, 100, 200, and 400 Amp units. Prevents plug insertion in a receptacle or connector wired for a different voltage. In installations where there are different line voltages, the special polarization option is desirable. This allows only plugs and receptacles wired for the same line voltage to be mated together. The receptacle or connector interior is positioned 22-1/2°, relative to the polarization rivet, to the right (as specified) of standard, and plug is polarized to correspond. Add suffix **-P4** to the standard or reverse service plug, receptacle or connector.

NEMA 4X Cap

Protects plug insulation and contacts from moisture, dirt, dust and corrosion when not in use. See product page for item number information.



Lock Collar

Secures Plug and Connector connections to prevent intentional disconnection by unauthorized personnel. For use with 60 and 100 Amp Series Plugs and Connectors. Collar clamps around fully tightened Plug and Connector and secured via a padlock. Order item PTL60100.



PLUGS AND RECEPTACLES: NEC/CEC ORDINARY LOCATION

APPLETON™

Powertite™ Series Pin and Sleeve Plugs, Connectors and Receptacles

NEC/CEC:
Listed for Ordinary (Unclassified) Locations
NEMA 3, 4, 4X

PLUGS AND RECEPTACLES: NEC/CEC ORDINARY LOCATION

Features at a Glance

Amp	Receptacle Types				Contacts			Reverse Service		
	Grounding Styles	Weatherproof Spring Door	NEMA 4X Screw Cap	NEMA 4X Clamp Cover	Brass with Beryllium Copper Springs	Copper with Borosilicate Bearings	Split-type Copper Contacts	Brass Ground Contacts	In Field	Factory Only
30	1 and 2	X	X		X			Style 2	X	
60	1 and 2	X	X		X			Style 2	X	
100	1 and 2	X	X		X			Style 2	X	
150	2	X	X		Copper			Style 2	X	
200	1 and 2	X		X			X	Style 2	X	
400	1 and 2					X		Style 2		X

Application Chart

Grounding Style	Wire/Pole	Single Phase		Grounding Style	Wire/Pole	Three Phase	
		With Neutral	Without Neutral			With Neutral	Without Neutral
Style 1 (Shell Only)	2W, 2P	L1+N+G	L1+L2+G	Style 1 (Shell Only)	2W, 2P		
	3W, 3P	L1+L2+N+G			3W, 3P		L1+L2+L3+G
	4W, 4P				4W, 4P	L1+L2+L3+N+G	
Style 2 (Shell and Extra Pole)	2W, 3P	L1+N+G	L1+L2+G	Style 2 (Shell and Extra Pole)	2W, 3P		
	3W, 4P	L1+L2+N+G			3W, 4P		L1+L2+L3+G

Range of Wire Sizes Accommodated in Powertite™ Plug and Receptacle Terminals

60 °C (140 °F) minimum wire ratings.

30, 60, 100, and 150 Amp				200 Amp			400 Amp		
Amps	Wire Recess Dia. (Inches)	Wire Range Building	Wire Range Extra Flex.	Wire Recess Dia. (Inches)	Conductor Size	Type Conductor	Solder Recess Dia. (Inches)	Conductor Size	Type Conductor
30	.281	#10 – #6	#10 – #8	0.687	250	General Wire	0.84	500 MCM	General Wire
60	.312	#6 – #2	#6 – #4		4/0	General Wire		400 MCM	Flex. Cable
100	.391	#4 – #1	#4 – #2		4/0	Flex. Cable		400 MCM	Extra Flex.
150	.525	#2 – 2/0	#2 – 2/0		3/0	Flex. Cable		1000 MCM	General wire
					3/0	Extra Flex.	1.25	900 MCM	General Wire
					2/0	Flex. Cable		800 MCM	Extra Flex.

Horsepower Ratings at Full-Load Current

Values are derived from NEC Article 430 Table 430.250. The voltages listed are nominal motor voltages.

Motor Phase	Amps	Motor Horsepower		
		240 Vac	480 Vac	600 Vac
Full-Load Current				
	30	10	20	25
	60	20	40	50
3-Phase	100	30	75	100
	150	50	100	150
	200	75	150	200

Horsepower Ratings for Emergency Disconnect Only

Plug may be withdrawn in an emergency if within these maximum HP ratings. Not for normal starting/stopping.

Motor Phase	Amps	Motor Horsepower			
		115 Vac	240 Vac	480 Vac	600 Vac
For Emergency Disconnect Only ①					
	30	3	7-1/2	15	20
	60	7-1/2	15	30	30
3-Phase	100	10	20	40	40
	150	Do Not Disconnect Under Load			
	200	20	40	50	50

① For 1-Phase Emergency Disconnect HP ratings please refer to each amperage section.

PowerTite™ 30 Amp Pin and Sleeve Plugs and Receptacles

600 Vac, 250 Vdc, 50-400 Hz

Pressure Wire Terminals – Wire Recess Diameter: .281". Wire Size Range: #10—#6 Building; #10—#8 Extra Flex.

NEC/CEC:

Listed for Ordinary (Unclassified) Locations
NEMA 3, 4, 4X



Grounding Style	Wire/Pole	Receptacle with AEE Mounting Box ①	Hub Size (Inches)	Receptacle Only ③	Metallic Clamping Ring Plug ②	Nonmetallic Clamping Ring Plug ②④	Plug Cable Dia. (Inches)
Style 1 (Shell Only)	2W, 2P	ADRE3022-50	1/2	ADR3022	ACP3022BC	—	.500 to 1.125
		ADRE3022-75	3/4				
	3W, 3P	ADRE3033-75	3/4	ADR3033	ACP3033BC	—	.500 to 1.125
		ADRE3033-100	1				
4W, 4P	ADRE3044-75	3/4	ADR3044	ACP3044BC	—	.500 to 1.125	
	ADRE3044-100	1					
Style 2 (Shell and Extra Pole)	2W, 3P	ADRE3023-75	3/4	ADR3023	ACP3023BC	—	.500 to 1.125
		ADRE3023-100	1				
	3W, 4P	ADRE3034-75	3/4	ADR3034	ACP3034BC	NMACP3034BC	.500 to 1.125
		ADRE3034-100	1				

Receptacles are provided with spring door and screw cover.
For Reverse Service, add suffix **-RS** to Catalog Number.
For Special Polarization, add suffix **-P4** to Catalog Number.

Horsepower Ratings at Full-Load Current

Below values are derived from NEC article 430 Table 430.250. The voltages listed are nominal motor voltages.

Motor Phase	Motor Horsepower		
	240 Vac	280 Vac	600 Vac
3-Phase	10HP	20HP	25HP

Horsepower Ratings for Emergency Disconnect Under Load

Plug may be withdrawn in an emergency if within these maximum HP ratings. Not for normal starting and stopping.

Motor Phase	Motor Horsepower			
	120 Vac	240 Vac	480 Vac	600 Vac
1-Phase	2HP	3HP	10HP	10HP
3-Phase	3HP	7-1/2HP	15HP	20HP

① For additional mounting boxes, see Aluminum Mounting Boxes.

② Plug and receptacle combination is NEMA 4X rated when clamping ring is fully tightened on receptacle.

③ Receptacle is NEMA 4X rated when screw cover is fully engaged when the receptacle is not in use.

④ Reverse service and special polarization options are not available on nonmetallic plugs.

Powertite™ 30 Amp Pin and Sleeve Connectors and Plugs

600 Vac, 250 Vdc, 50-400 Hz

Pressure Wire Terminals – Wire Recess Diameter: .281". Wire Size Range: #10—#6 Building; #10—#8 Extra Flex.

NEC/CEC:

Listed for Ordinary (Unclassified) Locations

NEMA 3, 4, 4X

PLUGS AND RECEPTACLES: NEC/CEC ORDINARY LOCATION



Grounding Style	Wire/Pole	Connector Body Only	Metallic Clamping Ring Plug ①	Connector/Plug Cable Dia. (Inches)
Style 1 (Shell Only)	2W, 2P	ARC3022BC	ACP3022BC	.500 to 1.125
	3W, 3P	ARC3033BC	ACP3033BC	.500 to 1.125
	4W, 4P	ARC3044BC	ACP3044BC	.500 to 1.125
Style 2 (Shell and Extra Pole)	2W, 3P	ARC3023BC	ACP3023BC	.500 to 1.125
	3W, 4P	ARC3034BC	ACP3034BC	.500 to 1.125

For Reverse Service, add suffix **-RS** to Catalog Number.

For Special Polarization, add suffix **-P4** to Catalog Number.

Pin and Sleeve Design

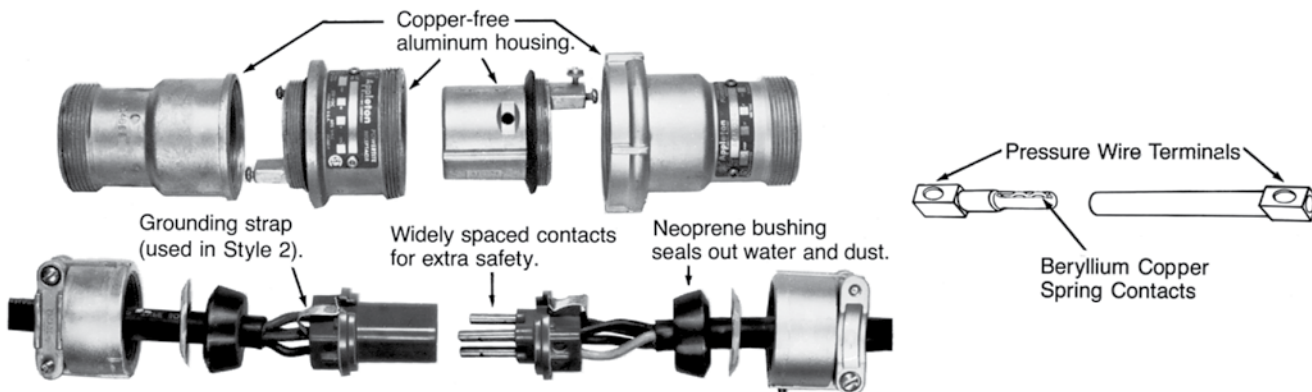

Energized contacts deeply recessed to reduce danger of accidental touching, minimize possibility of exposed arcs. Insulator quenches arcing, and is resistant to abnormal heat and to fire.

Plug mechanical cable clamps provide strain relief conductor connections, allow easy cable replacement.

Pressure wire terminals allow cable to be readily replaced when necessary. Terminal screws grip conductors firmly. Spring contacts provide constant pressure.

① Plug and connector body combination is NEMA 4X rated when clamping ring is fully tightened on connector body.

Powerlite™ 60 Amp Pin and Sleeve Plugs and Receptacles

600 Vac, 250 Vdc, 50-400 Hz

Pressure Wire Terminals – Wire Recess Diameter: .312". Wire Size Range: #6—#2 Building; #6—#4 Extra Flex.

NEC/CEC:

Listed for Ordinary (Unclassified) Locations
NEMA 3, 4, 4X

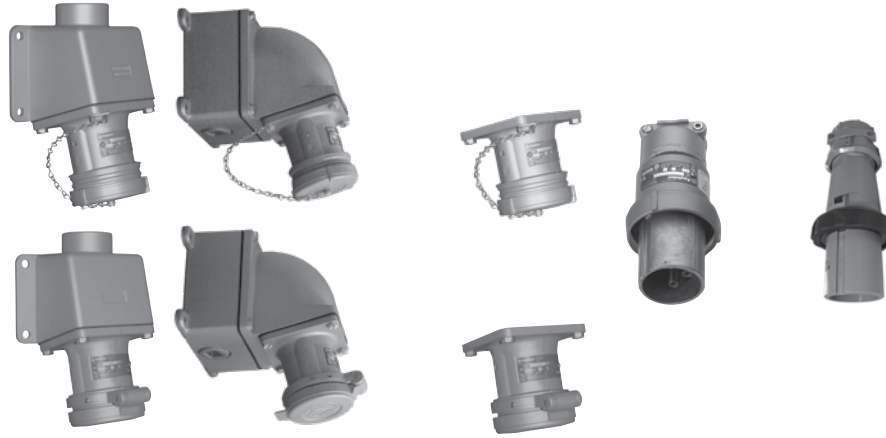

PLUGS AND RECEPTACLES: NEC/CEC ORDINARY LOCATION

APPLETON™

Grounding Style	Wire/Pole	Receptacle with AEE Mounting Box ①	Receptacle with AJA Mounting Box ①	Hub Size (Inches)	Receptacle Only ③	Metallic Clamping Ring Plug ②	Nonmetallic Clamping Ring Plug ②④	Plug Cable Dia. (Inches)
Style 1 (Shell Only)	2W, 2P	ADRE6022-100	ADJA6022-100	1	ADR6022	ACP6022BC	—	.500 to 1.375
		ADRE6022-125	ADJA6022-125	1-1/4				
	3W, 3P	ADRE6033-100	ADJA6033-100	1	ADR6033	ACP6033BC	—	.500 to 1.375
		ADRE6033-125	ADJA6033-125	1-1/4				
	4W, 4P	ADRE6044-125	ADJA6044-125	1-1/4	ADR6044	ACP6044BC	—	.500 to 1.375
		ADRE6044-150	ADJA6044-150	1-1/2				
Style 2 (Shell and Extra Pole)	2W, 3P	ADRE6023-100	ADJA6023-100	1	ADR6023	ACP6023BC	—	.500 to 1.375
		ADRE6023-125	ADJA6023-125	1-1/4				
	3W, 4P	ADRE6034-125	ADJA6034-125	1-1/4	ADR6034	ACP6034BC	NMACP6034BC	.500 to 1.375
		ADRE6034-150	ADJA6034-150	1-1/2				

Receptacles are provided with spring door and screw cover.
For Reverse Service, add suffix **-RS** to Catalog Number.
For Special Polarization, add suffix **-P4** to Catalog Number.

Horsepower Ratings at Full-Load Current

Below values are derived from NEC article 430 Table 430.250. The voltages listed are nominal motor voltages.

Motor Phase	240 Vac	480 Vac	600 Vac
3-Phase	20HP	40HP	50HP

Horsepower Ratings for Emergency Disconnect Under Load

Plug may be withdrawn in an emergency if within these maximum HP ratings. Not for normal starting and stopping.

Motor Phase	120 Vac	240 Vac	480 Vac	600 Vac
1-Phase	3HP	10HP	20HP	20HP
3-Phase	7-1/2HP	15HP	30HP	30HP

① For additional mounting boxes, see Aluminum Mounting Boxes.

② Plug and receptacle combination is NEMA 4X rated when clamping ring is fully tightened on receptacle.

③ Receptacle is NEMA 4X rated when screw cover is fully engaged when the receptacle is not in use.

④ Reverse service and special polarization options are not available on nonmetallic plugs.

Powertite™ 60 Amp Pin and Sleeve Connectors and Plugs

600 Vac, 250 Vdc, 50-400 Hz

Pressure Wire Terminals – Wire Recess Diameter: .312". Wire Size Range: #6—#2 Building; #6—#4 Extra Flex.

NEC/CEC:
Listed for Ordinary (Unclassified) Locations
NEMA 3, 4, 4X

PLUGS AND RECEPTACLES: NEC/CEC ORDINARY LOCATION



Grounding Style	Wire/Pole	Connector Body Only	Metallic Clamping Ring Plug ①	Connector/Plug Cable Dia. (Inches)
Style 1 (Shell Only)	2W, 2P	ARC6022BC	ACP6022BC	.500 to 1.375
	3W, 3P	ARC6033BC	ACP6033BC	.500 to 1.375
	4W, 4P	ARC6044BC	ACP6044BC	.500 to 1.375
Style 2 (Shell and Extra Pole)	2W, 3P	ARC6023BC	ACP6023BC	.500 to 1.375
	3W, 4P	ARC6034BC	ACP6034BC	.500 to 1.375

For Reverse Service, add suffix **-RS** to Catalog Number.
For Special Polarization, add suffix **-P4** to Catalog Number.

Pin and Sleeve Design

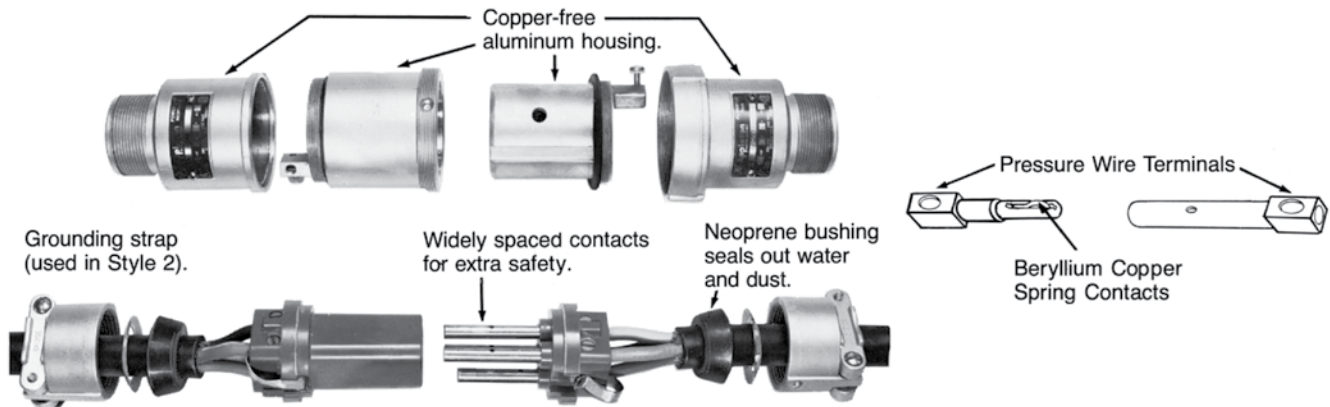

Energized contacts deeply recessed to reduce danger of accidental touching, minimize possibility of exposed arcs. Insulator quenches arcing, and is resistant to abnormal heat and to fire.

Plug mechanical cable clamps provide strain relief at conductor connections, allow easy cable replacement.

Pressure wire terminals allow cable to be readily replaced when necessary. Terminal screws grip conductors firmly. Spring contacts provide constant pressure.

① Plug and connector body combination is NEMA 4X rated when clamping ring is fully tightened on connector body.

Powertite™ 100 and 150 Amp Pin and Sleeve Plugs and Receptacles

600 Vac, 250 Vdc, 50-400 Hz

Pressure Wire Terminals – 100 Amp: Wire Recess Diameter: .391". Wire Size Range: #4—#1 Building; #4—#2 Extra Flex.

150 Amp: Wire Recess Diameter: .525". Wire Size Range: #2—2/0 Building; #2—#2/0 Extra Flex.

NEC/CEC:

Listed for Ordinary (Unclassified) Locations

NEMA 3, 4, 4X



PLUGS AND RECEPTACLES: NEC/CEC ORDINARY LOCATION

APPLETON™

Grounding Style	Wire/Pole	Receptacle with AJA Mounting Box ①	Hub Size (Inches)	Receptacle Only ③	Clamping Ring Plug ②	Plug Cable Dia. (Inches)
100 Amp Style 1 (Shell Only)	2W, 2P	ADJA1022-125	1-1/4	ADR1022	ACP1022CD	.875 to 1.906
		ADJA1022-150	1-1/2			
	3W, 3P	ADJA1033-125	1-1/4	ADR1033	ACP1033CD	.875 to 1.906
		ADJA1033-150	1-1/2			
4W, 4P		ADJA1044-150	1-1/2	ADR1044	ACP1044CD	.875 to 1.906
		ADJA1044-200	2			
100 Amp Style 2 (Shell and Extra Pole)	2W, 3P	ADJA1023-125	1-1/4	ADR1023	ACP1023CD	.875 to 1.906
		ADJA1023-150	1-1/2			
	3W, 4P	ADJA1034-150	1-1/2	ADR1034	ACP1034CD	.875 to 1.906
		ADJA1034-200	2			
150 Amp Style 2 (Shell and Extra Pole)	3W, 4P	ADJA15034-150	1-1/2	ADR15034	ACP15034CD	.875 to 1.906
		ADJA15034-200	2		ACP15034DE	1.250 to 2.187

Receptacles are provided with spring door and screw cover.

For Reverse Service, add suffix **-RS** to Catalog Number.

For Special Polarization for 100 Amp units, add suffix **-P4** to Catalog Number. (Not available for 150 Amp units.)

Horsepower Ratings at Full-Load Current

Below values are derived from NEC article 430 Table 430.250. The voltages listed are nominal motor voltages.

Amp	Motor Phase	240 Vac	Motor Horsepower 480 Vac	600 Vac
100	3-Phase	30HP	75HP	100HP
150	3-Phase	50HP	100HP	150HP

Horsepower Ratings for Emergency Disconnect Under Load

Not for normal starting and stopping, but plug may be withdrawn in an emergency if within these maximum HP ratings.

Amp	Motor Phase	120 Vac	240 Vac	Motor Horsepower 480 Vac	600 Vac
100	1-Phase	7-1/2HP	15HP	30HP	30HP
	3-Phase	10HP	20HP	40HP	40HP
150	3-Phase		Do Not Disconnect Under Load		

① For additional mounting boxes, see Aluminum Mounting Boxes.

② Plug and receptacle combination is NEMA 4X rated when clamping ring is fully tightened on receptacle.

③ Receptacle is NEMA 4X rated when screw cover is fully engaged when the receptacle is not in use.

Powertite™ 100 and 150 Amp Pin and Sleeve Connectors and Plugs

600 Vac, 250 Vdc, 50-400 Hz

Pressure Wire Terminals – 100 Amp: Wire Recess Diameter: .391". Wire Size Range: #4—#1 Building; #4—#2 Extra Flex.

150 Amp: Wire Recess Diameter: .525". Wire Size Range: #2—2/0 Building; #2—#2/0 Extra Flex.

NEC/CEC:

Listed for Ordinary (Unclassified) Locations
NEMA 3, 4, 4X

PLUGS AND RECEPTACLES: NEC/CEC ORDINARY LOCATION

APPLETON™



Grounding Style	Wire/Pole	Connector Body Only	Clamping Ring Plug ①	Connector/Plug Cable Dia. (Inches)
100 Amp Style 1 (Shell Only)	2W, 2P	ARC1022CD	ACP1022CD	.875 to 1.906
	3W, 3P	ARC1033CD	ACP1033CD	.875 to 1.906
	4W, 4P	ARC1044CD	ACP1044CD	.875 to 1.906
100 Amp Style 2 (Shell and Extra Pole)	2W, 3P	ARC1023CD	ACP1023CD	.875 to 1.906
	3W, 4P	ARC1034CD	ACP1034CD	.875 to 1.906
150 Amp ② Style 2 (Shell and Extra Pole)	3W, 4P	ARC15034CD	ACP15034CD	.875 to 1.906
	3W, 4P	ARC15034DE	ACP15034DE	1.250 to 2.187

For Reverse Service, add suffix **-RS** to Catalog Number.

For Special Polarization for 100 Amp units, add suffix **-P4** to Catalog Number. (Not available for 150 Amp units.)

Pin and Sleeve Design

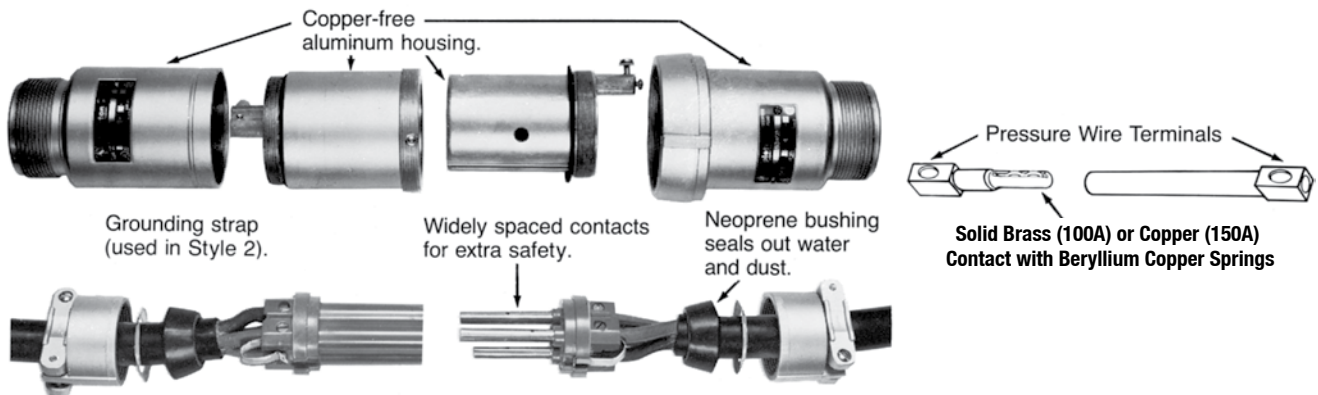

Energized contacts deeply recessed to reduce danger of accidental touching, minimize possibility of exposed arcs. Insulator quenches arcing, and is resistant to abnormal heat and to fire.

Plug mechanical cable clamps provide strain relief at conductor connections, allow easy cable replacement.

Pressure wire terminals allow cable to be readily replaced when necessary. Terminal screws grip conductors firmly. Spring contacts provide constant pressure.

① Plug and receptacle combination is NEMA 4X rated when clamping ring is fully tightened on receptacle.

② Powertite 150 Amp ARC connectors are not UL listed or CSA certified.

Powerlite™ Lock Collar 60 and 100 Amp

For Plugs and Connectors

PLUGS AND RECEPTACLES: NEC/CEC ORDINARY LOCATION



Applications

- Secures Plug and Connector connections to prevent intentional disconnection by unauthorized personnel.
- For use with 60 and 100 Amp Series Plugs and Connectors.
- Collar clamps around fully tightened Plug and Connector and secured via a padlock.

Standard Materials

- Shell: PA6 plastic
- Rubber inserts: NR rubber
- Padlock: Stainless steel



Open View



Keyed Padlock Feature



Closed View

Ordering Information

Catalog Number	Amp	For Use With 60 Amp Series Plug and Connector	For Use With 100 Amp Series Plug and Connector
PTLC60100	60 & 100	ACP6022BC & ARC6022BC	ACP1022CD & ARC1022CD
		ACP6033BC & ARC6033BC	ACP1033CD & ARC1033CD
		ACP6044BC & ARC6044BC	ACP1044CD & ARC1044CD
		ACP6023BC & ARC6023BC	ACP1023CD & ARC1023CD
		ACP6034BC & ARC6034BC	ACP1034CD & ARC1034CD

Powerlite™ 30, 60, and 100 Amp Caps For Plug

NEC/CEC:
Listed for Ordinary (Unclassified) Locations
NEMA 4X

PLUGS AND RECEPTACLES: NEC/CEC ORDINARY LOCATION

Applications

- Protects insulation and plug contacts from excessive moisture, dirt, dust, and corrosion when portable equipment is not in use.
- For use with 30 Amp 3-Pole and 4-Pole, 60 Amp 4-Pole and 100 Amp 4-Pole plugs.
- Cap is secured to plug by aviation cable. When in use the cap is held in place with standard plug clamping ring.

Standard Materials

- Cap: ABS plastic

Ordering Information

Catalog Number	Amp	For Use With
ACPCAP3034	30	ACP3023BC
		ACP3033BC
		ACP3034BC
		ACP3044BC
ACPCAP6004	60	ACP6034BC
		ACP6044BC
ACPCAP1004	100	ACP1034CD
		ACP1044CD



APPLETON™

Aluminum Mounting Boxes

For Powertite™ 30, 60, 100, and 150 Amp Receptacles

NEC/CEC:
Listed for Ordinary (Unclassified) Locations
NEMA 3, 4, 4X

30 Amp



Hub Size (Inches)	AEE	AERH	AERC	AERA
1/2	AEE13	AERH13	AERC13	AERA13
3/4	AEE23	AERH23	AERC23	AERA23
1	AEE33	AERH33	AERC33	AERA33

60 and 100 Amp



Hub Size (Inches)	AEE	AERH	AERC	AERA
1	AEE36	AERH36	AERC36	AERA36
1-1/4	AEE46	AERH46	AERC46	AERA46
1-1/2	AEE56	AERH56	AERC56	AERA56

60, 100, and 150 Amp



Hub Size (Inches)	AJA Back Box and Adapter ①	Angle Adapter Only
1	AJA310	
1-1/4	AJA410	AJA100
1-1/2	AJA510	
2	AJA610	

Replacement Receptacle Mounting Gasket

Amp	Back Box Type	Part Number
30	AEE, AERH, AERC, AERA	69060871000
60, 100	AEE, AERH, AERC, AERA	69060567000
60, 100, 150	AJA	69009497000

① Feed-Thru box furnished with one close-up plug in bottom recessed hub.

PLUGS AND RECEPTACLES: NEC/CEC ORDINARY LOCATION

APPLETON™

Powerlite™ 30, 60, 100, and 150 Amp Replacement Interiors

600 Vac, 250 Vdc, 50-400 Hz

NEC/CEC:
Listed for Ordinary (Unclassified) Locations
NEMA 3, 4, 4X

PLUGS AND RECEPTACLES: NEC/CEC ORDINARY LOCATION

APPLETON™

30 Amp ①



Grounding Style	Wire/Pole	Receptacle	Plug	Receptacle	Plug
Style 1 (Shell Only)	2W, 2P	ARI-3022	API-3022	—	—
	3W, 3P	ARI-3033	API-3033	—	—
	4W, 4P	ARI-3044	API-3044	—	—
Style 2 (Shell and Extra Pole)	2W, 3P	—	—	ARI-3023	API-3023
	3W, 4P	—	—	ARI-3034	API-3034

60 Amp ①



Grounding Style	Wire/Pole	Receptacle	Plug	Receptacle	Plug
Style 1 (Shell Only)	2W, 2P	ARI-6022	API-6022	—	—
	3W, 3P	ARI-6033	API-6033	—	—
	4W, 4P	ARI-6044	API-6044	—	—
Style 2 (Shell and Extra Pole)	2W, 3P	—	—	ARI-6023	API-6023
	3W, 4P	—	—	ARI-6034	API-6034

100 and 150 Amp ①









Grounding Style	Wire/Pole	Receptacle	Plug	Receptacle	Plug
Style 1 (Shell Only)	2W, 2P	ARI-1022	API-1022	—	—
	3W, 3P	ARI-1033	API-1033	—	—
	4W, 4P	ARI-1044	API-1044	—	—
Style 2 (Shell and Extra Pole)	2W, 3P	—	—	ARI-1023	API-1023
	3W, 4P	—	—	ARI-1034	API-1034
150 Amp Style 2 (Shell and Extra Pole)	3W, 4P	—	—	ARI-15034	API-15034

① Pins and sleeves are not sold separately.

Powerlite™ 30, 60, 100, and 150 Amp Replacement Parts

600 Vac, 250 Vdc, 50-400 Hz

NEC/CEC:
Listed for Ordinary (Unclassified) Locations
NEMA 3, 4, 4X

	Description	Catalog Number
ACP Plug Clamping Ring — Includes Gasket		
	30 Amp — 2-, 3- and 4-Pole	CLMPR30
	30 Amp — 3-Wire, 4-Pole	30CRING ①
	60 Amp — 2- and 3-Pole	CLMPR23P60
	60 Amp — 4-Pole	CLMPR4P60
	100 Amp — 2- and 3-Pole	CLMPR23P100
	100 and 150 Amp — 4-Pole	CLMPR4P100
Receptacle Spring Cover — Includes Gasket		
	30 Amp — 2-, 3- and 4-Pole	PTSC30
	60 Amp — 2- and 3-Pole	PTSC60A
	60 Amp — 4-Pole	PTSC60B
	100 Amp — 2- and 3-Pole	PTSC100A
	100 and 150 Amp — 4-Pole	PTSC100B
Receptacle Threaded Cover — Includes Gasket and Chain		
	30 Amp — 2, 3, and 4-Pole	PTTC30
	30 Amp — 3 Wire, 4-Pole	30SCAP ①
	60 Amp — 2- and 3-Pole	PTTC60A
	60 Amp — 4-Pole	PTTC60B
	100 Amp — 2- and 3-Pole	PTTC100A
	100 and 150 Amp — 4-Pole	PTTC100B
Bushing Bags and Crown Bushings for Plugs and Cable Connectors		
	30 Amp	PTGB30
	60 Amp	PTGB60
	100 Amp and 150 Amp (CD)	PTGBCD
	150 Amp (DE)	PTGBDE
Universal Plug Bushing		
	30 and 60 Amp Cable Range 0.300" – 9.00" Package of 10	PTGBUBC
Receptacle Ground Lug Kit		
	30 Amp Receptacle Ground Lug Kit. Wire Well ID 0.272"	PTRGL30
	60 Amp Receptacle Ground Lug Kit. Wire Well ID 0.312"	PTRGL60
	100 Amp Receptacle Ground Lug Kit. Wire Well ID 0.389" ②	PTRGL100

PLUGS AND RECEPTACLES: NEC/CEC ORDINARY LOCATION

APPLETON™

① For use with 30 Amp Powerlite™ plugs and WSR/WSRD/JBR/EBR/DBR receptacles.
② Ground lug is cast into the housing after 09/2008.

Powertite™ 30, 60, 100, and 150 Amp Mounted Receptacle

600 Vac, 250 Vdc, 50-400 Hz

NEC/CEC:
Listed for Ordinary (Unclassified) Locations
NEMA 3, 4, 4X

PLUGS AND RECEPTACLES: NEC/CEC ORDINARY LOCATION

APPLETON™

Dimensions in Millimeters (Inches)

Receptacle Mounted on AEE Box

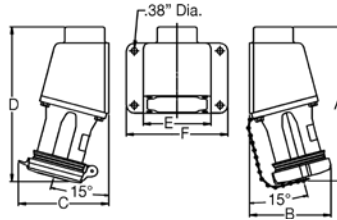

Amp	Dimensions in Millimeters (Inches)					
	A	B	C	D	E	F
30	174.7 (6.88)	89.6 (3.45)	100.3 (3.95)	181.1 (7.13)	107.9 (4.25)	127.0 (5.00)
60	247.6 (9.75)	120.1 (4.73)	126.4 (4.98)	254.0 (10.00)	136.6 (5.38)	162.0 (6.38)

Receptacle Mounted on AJA Box

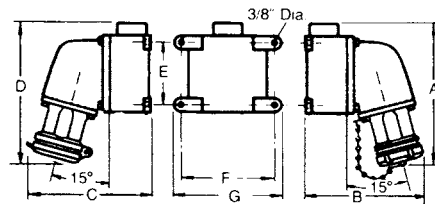

Amp	Dimensions in Millimeters (Inches)						
	A	B	C	D	E	F	G
60	244.6 (9.63)	203.2 (8.00)	223.7 (8.81)	271.5 (10.69)	123.9 (4.88)	174.7 (6.88)	200.15 (7.88)
100 and 150	290.5 (11.44)	228.6 (9.00)	233.4 (9.19)	300.2 (11.82)	123.9 (4.88)	174.7 (6.88)	200.15 (7.88)

ADR Receptacle

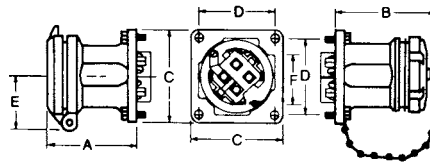

Amp	No. Poles	Dimensions in Millimeters (Inches)					
		A	B	C	D	E	F
30	2,3,4	71.1 (2.80)	81.0 (3.19)	85.8 (3.38)	69.0 (2.72)	52.3 (2.06)	69.8 (2.75)
60	2,3	123.9 (4.88)	117.6 (4.63)	107.9 (4.25)	88.9 (3.50)	58.6 (2.31)	78.7 (3.10)
60	4	123.9 (4.88)	117.6 (4.63)	107.9 (4.25)	88.9 (3.50)	61.9 (2.44)	85.0 (3.35)
100	2,3	129.5 (5.10)	139.7 (5.50)	107.9 (4.25)	88.9 (3.50)	61.9 (2.44)	86.3 (3.40)
100 and 150	4	129.5 (5.10)	139.7 (5.50)	107.9 (4.25)	88.9 (3.50)	65.0 (2.56)	91.4 (3.60)

Powerlite™ 30, 60, 100, and 150 Amp Connector and Plug

600 Vac, 250 Vdc, 50-400 Hz

NEC/CEC:
Listed for Ordinary (Unclassified) Locations
NEMA 3, 4, 4X

Dimensions in Millimeters (Inches)

ARC Cable Connector

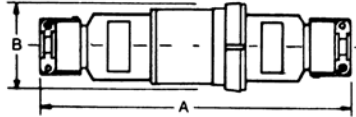

Amp	Dimensions in Millimeters (Inches)	
	A	B
30	266.7 (10.50)	79.5 (3.13)
60	336.5 (13.25)	96.7 (3.81)
100	406.4 (16.00)	107.9 (4.25)
150	406.4 (16.00)	107.9 (4.25)

ACP Plug

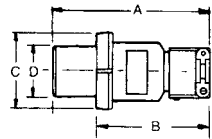

Amp	No. Poles	Dimensions in Millimeters (Inches)			
		A	B	C	D
30	2,3,4	152.4 (6.00)	120.6 (4.75)	79.5 (3.13)	47.2 (1.86)
60	2,3	198.3 (7.81)	125.4 (4.94)	88.9 (3.50)	56.6 (2.23)
60	4	198.3 (7.81)	125.4 (4.94)	96.7 (3.81)	64.7 (2.55)
100	2,3	266.7 (10.50)	168.4 (6.63)	101.6 (4.00)	62.7 (2.47)
100	4	266.7 (10.50)	168.4 (6.63)	107.9 (4.25)	69.0 (2.72)
150 (CD)	4	266.7 (10.50)	168.4 (6.63)	107.9 (4.25)	69.0 (2.72)
150 (DE)	4	340.3 (13.40)	247.1 (9.73)	107.9 (4.25)	69.0 (2.72)

NMACP Plug

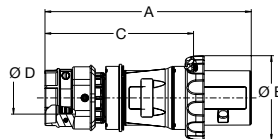

Amp	No. Poles	Dimensions in Millimeters (Inches)			
		A	B	C	D Min — Max
30	4	187.0 (7.36)	63.0 (2.48)	145.0 (5.71)	11.0 - 24.5 (0.43 - 0.97)
60	4	245.0 (9.65)	100.0 (3.94)	174.0 (6.85)	14.5 - 36.0 (0.57 - 1.42)

PLUGS AND RECEPTACLES: NEC/CEC ORDINARY LOCATION

APPLETON™

Powertite™ 30, 60, 100, and 150 Amp Mounting Box

600 Vac, 250 Vdc, 50-400 Hz

NEC/CEC:
Listed for Ordinary (Unclassified) Locations
NEMA 3, 4, 4X

Dimensions in Millimeters (Inches)

AJA Mounting Boxes

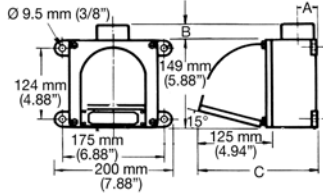

Amp	Hub Size (Inches)	Dimensions in Millimeters (Inches)		
		A	B ①	C
60, 100 and 150	1	28.7 (1.13)	14.2 (0.56)	203.2 (8.0)
	1-1/4	28.7 (1.13)	14.2 (0.56)	203.2 (8.0)
	1-1/2	38.1 (1.50)	14.2 (0.56)	203.2 (8.0)
	2	38.1 (1.50)	14.2 (0.56)	203.2 (8.0)

AJA100 Angle Adapter

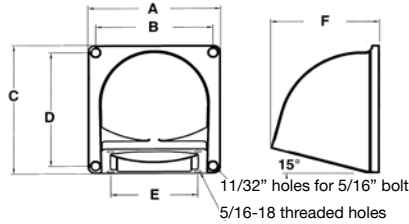

Dimensions in Millimeters (Inches)					
A	B	C	D	E	F
149.0 (5.87)	131.5 (5.18)	149.0 (5.87)	131.5 (5.18)	88.9 (3.50)	122.1 (4.81)

① AJA has two hubs. Close-up plug furnished in bottom recessed hub.

Powerlite™ 30, 60, 100, and 150 Amp Mounting Box

600 Vac, 250 Vdc, 50-400 Hz

NEC/CEC:
Listed for Ordinary (Unclassified) Locations
NEMA 3, 4, 4X

Dimensions in Millimeters (Inches)

AERA ①, AERC ② and AERH Mounting Boxes

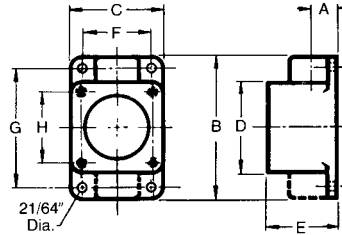

Amp	Hub Size (Inches)	Dimensions in Millimeters (Inches)								
		A ①	B ②	C	D	E	F	G	H	J
30	1/2	17.5 (0.69)	134.8 (5.31)	85.8 (3.38)	85.8 (3.38)	63.5 (2.50)	66.8 (2.63)	115.8 (4.56)	69.0 (2.72)	23.8 (0.94)
30	3/4	19.0 (0.75)	134.8 (5.31)	85.8 (3.38)	85.8 (3.38)	63.5 (2.50)	66.8 (2.63)	115.8 (4.56)	69.0 (2.72)	23.8 (0.94)
30	1	20.5 (0.81)	134.8 (5.31)	85.8 (3.38)	85.8 (3.38)	63.5 (2.50)	66.8 (2.63)	115.8 (4.56)	69.0 (2.72)	23.8 (0.94)
60	1	20.5 (0.81)	165.1 (6.50)	107.9 (4.25)	107.9 (4.25)	79.5 (3.13)	88.9 (3.50)	149.3 (5.88)	88.9 (3.50)	35.0 (1.38)
60	1-1/4	23.8 (0.94)	165.1 (6.50)	107.9 (4.25)	107.9 (4.25)	79.5 (3.13)	88.9 (3.50)	149.3 (5.88)	88.9 (3.50)	35.0 (1.38)
60	1-1/2	25.4 (1.00)	165.1 (6.50)	107.9 (4.25)	107.9 (4.25)	79.5 (3.13)	88.9 (3.50)	149.3 (5.88)	88.9 (3.50)	35.0 (1.38)

AEE Mounting Box

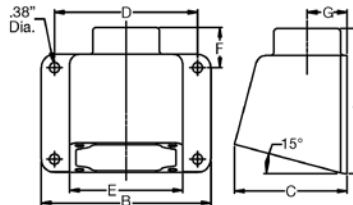

Amp	Hub Size (Inches)	Dimensions in Millimeters (Inches)						
		A	B	C	D	E	F	G
30	1/2, 3/4, 1	104.6 (4.12)	127.0 (5.00)	84.5 (3.33)	107.9 (4.25)	85.8 (3.38)	29.9 (1.18)	27.9 (1.10)
60	1, 1-1/4, 1-1/2	137.4 (5.41)	162.0 (6.38)	107.4 (4.23)	136.6 (5.38)	107.9 (4.25)	38.1 (1.50)	38.1 (1.50)

① Dimension "A" for AERA only.
② Dimension "B" for AERC only.

Powertite™ 200 Amp Pin and Sleeve Plugs and Receptacles

600 Vac, 250 Vdc, 50-400 Hz. Spring Door Cover. Wire Recess Diameter: .687". Wire Size Range: 250 MCM-#1/0. Pressure Wire Terminals ①.

NEC/CEC:
Listed for Ordinary (Unclassified) Locations
NEMA 3, 4, 4X



PLUGS AND RECEPTACLES: NEC/CEC ORDINARY LOCATION

Grounding Style	Wire/Pole	Receptacle with AJA Mounting Box ②	Hub Size (Inches)	Receptacle Only ③	Plug Only	Cable Dia. (Inches)
Style 1 (Shell Only)	3W, 3P	ADJA20033-150	1-1/2	ADR20033	AP20033E	.875 to 2.500
		ADJA20033-200	2			
		ADJA20033-250	2-1/2			
	4W, 4P	ADJA20044-200	2	ADR20044	AP20044E	
		ADJA20044-250	2-1/2			
Style 2 (Shell and Extra Pole)	2W, 3P	ADJA20023-150	1-1/2	ADR20023	AP20023E	.875 to 2.500
		ADJA20023-200	2			
		ADJA20023-250	2-1/2			
	3W, 4P	ADJA20034-150	1-1/2	ADR20034	AP20034E	
		ADJA20034-200	2			
		ADJA20034-250	2-1/2			

For Reverse Service add suffix **-RS** to Catalog Number.
For Special Polarization, add suffix **-P4** to Catalog Number.

Maximum Conductor Size

Wire Recess Dia. (Inches)	Conductor Size	Max. Strand	Type Conductor
0.687	250 MCM	37	General Wire
	4/0	19	General Wire
	4/0	516	Flexible Cable
	3/0	427	Extra Flexible Cable
	2/0	259	Flexible Cable
	1/0	259	Flexible Cable

Horsepower Ratings at Full-Load Current

Below values are derived from NEC article 430 Table 430.250. The voltages listed are nominal motor voltages.

Motor Phase	Motor Horsepower		
	240 Vac	480 Vac	600 Vac
3-Phase	75HP	150HP	200HP

Horsepower Ratings for Emergency Disconnect Under Load

Plug may be withdrawn in an emergency if within these maximum HP ratings. Not for normal starting and stopping.

Motor Phase	Motor Horsepower			
	120 Vac	240 Vac	480 Vac	600 Vac
1-Phase	15HP	30HP	40HP	40HP
3-Phase	20HP	40HP	50HP	50HP

① Adapters for #4-#1 wire available, see Powertite™ 200 and 400 Amp Replacement Parts.

② For additional mounting boxes, see Aluminum Mounting Boxes.

③ Receptacle meets NEMA 3, 4, 4X with plug fully inserted and wing nuts fully tightened or spring door installed with wing nuts fully tightened.

Powertite™ 200 Amp Pin and Sleeve Plugs, Connectors and Receptacles

600 Vac, 250 Vdc, 50-400 Hz. Clamp Cover. Wire Recess Diameter: .687". Wire Size Range: 250 MCM-#1/0. Pressure Wire Terminals ①.

NEC/CEC:
Listed for Ordinary (Unclassified) Locations
NEMA 3, 4, 4X



Grounding Style	Wire/Pole	Receptacle with AJA Mounting Box ②	Hub Size (Inches)	Receptacle Only ③	Connector Body Only ④	Plug Only ④	Cable Dia. (Inches)
Style 1 (Shell Only)	3W, 3P	AJA20033-150	1-1/2	AR20033	ARC20033E	AP20033E	.875 to 2.500
		AJA20033-200	2				
		AJA20033-250	2-1/2				
	4W, 4P	AJA20044-200	2	AR20044	ARC20044E	AP20044E	
		AJA20044-250	2-1/2				
		AJA20023-150	1-1/2				
Style 2 (Shell and Extra Pole)	2W, 3P	AJA20023-200	2				
		AJA20023-250	2-1/2				
		AJA20034-150	1-1/2	AR20034	ARC20034E	AP20034E	
3W, 4P	AJA20034-200	2					
	AJA20034-250	2-1/2					

For Reverse Service add suffix **-RS** to Catalog Number.
For Special Polarization, add suffix **-P4** to Catalog Number.

Pin and Sleeve Design

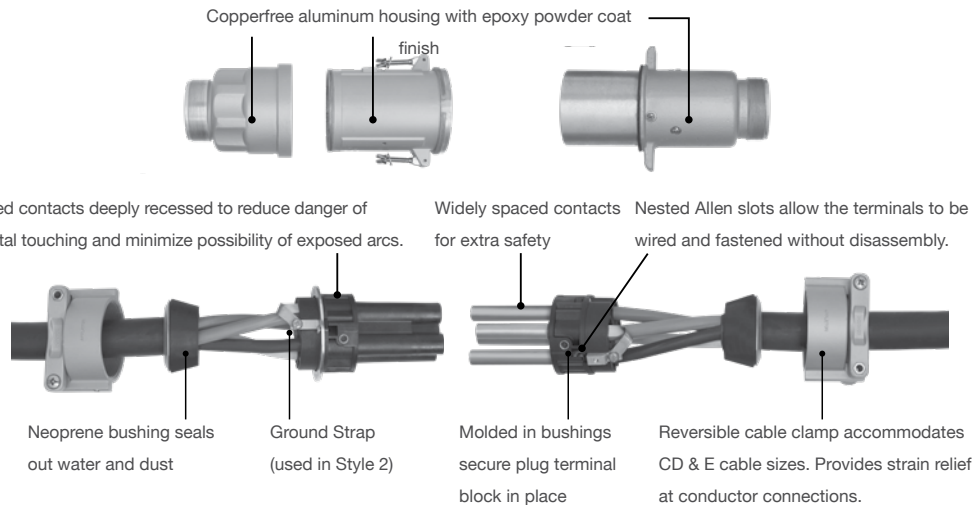

① Note: Adapters for #4-#1 wire available, see Powertite™ 200 and 400 Amp Replacement Parts.
② For additional mounting boxes, see Aluminum Mounting Boxes.
③ Receptacle meets NEMA 3, 4, 4X with plug fully inserted and wing nuts fully tightened or clamp cover installed with wing nuts fully tightened.
④ Plug and connector body combination is NEMA 4X rated when wing nuts are fully tightened on connector body.

Powertite™ 400 Amp Pin and Sleeve Plugs and Receptacles

Weatherproof

600 Vac, 250 Vdc, 50-400 Hz. Clamp Cover. Wire Recess Diameter: .84" or 1.25". Wire Size Range: 400MCM—1000MCM. Solder Wire Terminals.

NEC/CEC:

Listed for Ordinary (Unclassified) Locations
NEMA 4 – Optional

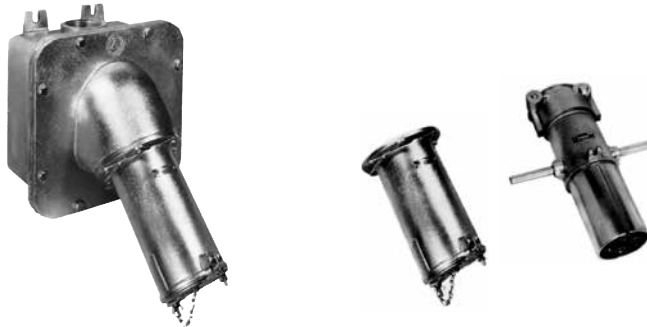

PLUGS AND RECEPTACLES: NEC/CEC ORDINARY LOCATION

APPLETON™

Wire Recess Dia. (Inches)	Grounding Style	Wire/Pole	Receptacle with AJA Mounting Box ②	Hub Size (Inches) ③	Receptacle Only ②	Plug Only	Cable Dia. (Inches)
0.84 ①	Style 1 (Shell Only)	3W, 3P	AJA40033-400	4	AR40033	AP40033E	1.875 to 2.500
		4W, 4P	AJA40044-400		AR40044	AP40044E	1.875 to 2.500
		4W, 4P	AJA40044-400N4		AR40044N4	AP40044E	1.875 to 2.500
	Style 2 (Shell and Extra Pole)	2W, 3P	AJA40023-400	4	AR40023	AP40023E	1.875 to 2.500
		3W, 4P	AJA40034-400		AR40034	AP40034E	1.875 to 2.500
		3W, 4P	AJA40034-400N4		AR40034N4	AP40034E	1.875 to 2.500
1.25	Style 1 (Shell Only)	3W, 3P	AJA40133-400	4	AR40133	AP40133F	2.500 to 3.000
					AP40133G	3.000 to 3.500	
		4W, 4P	AJA40144-400		AR40144	AP40144F	2.500 to 3.000
	Style 2 (Shell and Extra Pole)	4W, 4P	AJA40144-400N4	4	AR40144N4	AP40144G	3.000 to 3.500
		2W, 3P	AJA40123-400	4	AR40123	AP40123F	2.500 to 3.000
					AP40123G	3.000 to 3.500	
		3W, 4P	AJA40134-400	4	AR40134	AP40134F	2.500 to 3.000
					AP40134G	3.000 to 3.500	
		3W, 4P	AJA40134-400N4	4	AR40134N4	AP40134G	3.000 to 3.500

Solder wire terminals standard on all models.

For Reverse Service add suffix **-RS** to Catalog Number.

For Special Polarization add suffix **-P4** to Catalog Number.

Note: Box can be turned for vertical or horizontal mounting.

Maximum Conductor Size

400 Amp not horsepower rated. Plug is for disconnecting use only – not for current rupturing.

Solder Recess Dia. (Inches)	Conductor Size	Max. Strand	Type Conductor
0.84	500 MCM	37	General Wire
	400 MCM	259	Flexible Cable
	400 MCM	427	Extra Flexible Cable
1.25	1000 MCM	61	General Wire
	800 MCM	703	Extra Flexible Cable

① Pressure terminal kits available for .84 wire recess size only to convert solder terminal to pressure terminal. See Replacement Parts page.

② 400 Amp versions with the **-N4** suffix are NEMA 4 rated.

③ Has feed-thru 4" tapped openings. Supplied with one 4" to 3" reducer and one 4" close-up plug.

PowerTite™ 400 Amp Pin and Sleeve Connectors and Plugs

Weatherproof

600 Vac, 250 Vdc, 50-400 Hz. Wire Recess Diameter: .84" or 1.25". Wire Size Range: 400MCM—1000MCM. Solder Wire Terminals.

NEC/CEC:

Listed for Ordinary (Unclassified) Locations
NEMA 4 – Optional

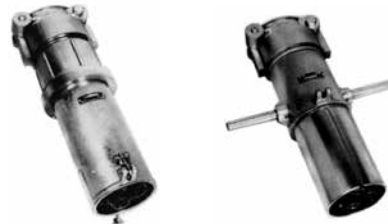

PLUGS AND RECEPTACLES: NEC/CEC ORDINARY LOCATION

APPLETON™

Wire Recess Dia. (Inches)	Grounding Style	Wire/Pole	Connector Body Only	Plug Only	Cable Dia. (Inches)
0.84 Ⓢ	Style 1 (Shell Only)	3W, 3P	ARC40033E	AP40033E	1.875 to 2.500
		4W, 4P	ARC40044E	AP40044E	1.875 to 2.500
	Style 2 (Shell and Extra Pole)	2W, 3P	ARC40023E	AP40023E	1.875 to 2.500
		3W, 4P	ARC40034E	AP40034E	1.875 to 2.500
1.25	Style 1 (Shell Only)	3W, 3P	ARC40133F	AP40133F	2.500 to 3.000
			ARC40133G	AP40133G	3.000 to 3.500
		4W, 4P	ARC40144F	AP40144F	2.500 to 3.000
		ARC40144G	AP40144G	3.000 to 3.500	
	Style 2 (Shell and Extra Pole)	2W, 3P	ARC40123F	AP40123F	2.500 to 3.000
			ARC40123G	AP40123G	3.000 to 3.500
		3W, 4P	ARC40134F	AP40134F	2.500 to 3.000
			ARC40134G	AP40134G	3.000 to 3.500

Solder wire terminals standard on all models.

For Reverse Service add suffix **-RS** to Catalog Number.

For Special Polarization add suffix **-P4** to Catalog Number.

Pin and Sleeve Design

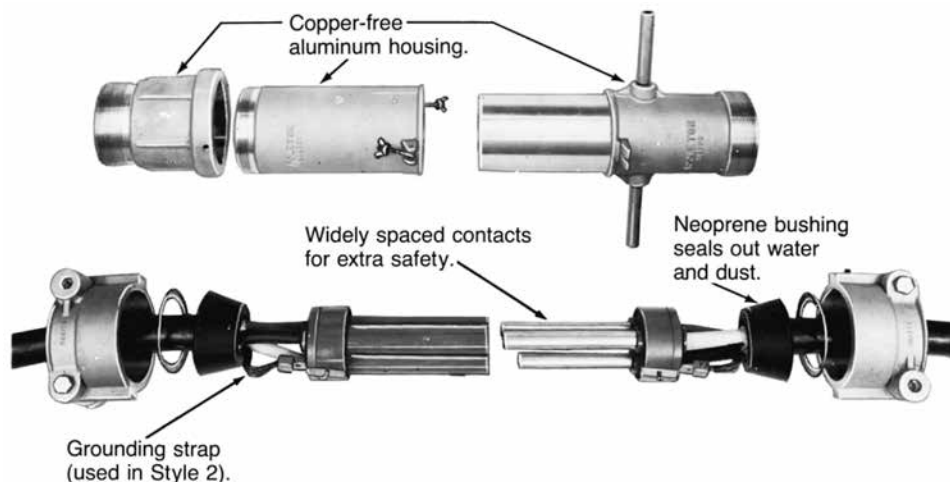

Energized contacts deeply recessed to reduce danger of accidental touching, minimize possibility of exposed arcs. Insulator quenches arcing, and is resistant to abnormal heat and to fire.

Plug mechanical cable clamps provide strain relief at conductor connections, allow easy cable replacement.

© Pressure terminal kits available for .84 wire recess size only to convert solder terminal to pressure terminal. See Replacement Parts page.

Visit our website at www.appletonelec.com or contact us at (800) 621-1506 or +33.3.22.54.27.54.
© January 2024

Powerlite™ 200 and 400 Amp Pin and Sleeve Connectors and Plugs

Mounting Boxes and Replacement Interiors. 600 Vac, 250 Vdc, 50-400 Hz.

NEC/CEC — 200 Amp:
Listed for Ordinary (Unclassified) Locations
NEMA 3, 4, 4X

NEC/CEC — 400 Amp:
Listed for Ordinary (Unclassified) Locations
NEMA 4 — Optional

PLUGS AND RECEPTACLES: NEC/CEC ORDINARY LOCATION

APPLETON™

200 Amp Mounting Boxes and Angle Adapter



Hub Size (Inches)	AJB	AJA	AJA200 (Angle Adapter Only)
1-1/2 NPT	—	AJA520	AJA200
2 NPT	AJB620	AJA620	AJA200
2-1/2 NPT	—	AJA720	AJA200
2-3/8 (Slip Hole)	AJB238	—	—

400 Amp Mounting Box and Angle Adapter



Hub Size (Inches)	AJAC ①	AJA400 (Angle Adapter Only)
4	AJAC400	AJA400

200 Amp Interiors ②③



Grounding Style	Wire/Pole	Receptacle	Plug	Receptacle	Plug
Style 1 (Shell Only)	3W, 3P	ARI20033-B	API20033-B	—	—
	4W, 4P	ARI20044-B	API20044-B	—	—
Style 2 (Shell and Extra Pole)	2W, 3P	—	—	ARI20023-B	API20023-B
	3W, 4P	—	—	ARI20034-B	API20034-B

400 Amp Interiors ③



Wire Recess Dia. (Inches)	Grounding Style	Wire/Pole	Receptacle	Plug	Receptacle	Plug
.84	Style 1 (Shell Only)	3W, 3P	ARI40033	API40033	—	—
		4W, 4P	ARI40044	API40044	—	—
	Style 2 (Shell and Extra Pole)	2W, 3P	—	—	ARI40023	API40023
		3W, 4P	—	—	ARI40034	API40034
1.25	Style 1 (Shell Only)	3W, 3P	ARI40133	API40133	—	—
		4W, 4P	ARI40144	API40144	—	—
	Style 2 (Shell and Extra Pole)	2W, 3P	—	—	ARI40123	API40123
		3W, 4P	—	—	ARI40134	API40134

① Has feed-thru 4" tapped openings. Supplied with one 4" to 3" reducer and one 4" close-up plug.

② 200 Amp replacement interiors ending with -B correspond to Model B version and those without -B correspond to original version. Model B Interiors ARE NOT backwards compatible with original version.







③ Pins and sleeves are not sold separately.

Powerlite™ 200 and 400 Amp Replacement Parts

600 Vac, 250 Vdc, 50-400 Hz.

NEC/CEC – 200 Amp:
Listed for Ordinary (Unclassified) Locations
NEMA 3, 4, 4X

NEC/CEC – 400 Amp:
Listed for Ordinary (Unclassified) Locations
NEMA 4 – Optional

	Description	Catalog Number
Receptacle Covers		
	Spring Cover – Includes Gasket	
	200 Amp – 2- and 3-Pole	PTLC200A
	200 Amp – 4-Pole	PTLC200B
	Clamping Cover – Includes Gasket and Chain	
	200 Amp – 2- and 3-Pole	PTBC200A
	200 Amp – 4-Pole	PTBC200B
	400 Amp – 2- and 3-Pole	PTBC400A
	400 Amp – 4-Pole	PTBC400B
Bushing Bags for Plugs and Cable Connectors		
	200 Amp - Suffix E	PTGB200E
	400 Amp - Suffix E	PTGB400E
	400 Amp - Suffix F	PTGB400F
	400 Amp - Suffix G	PTGB400G
Receptacle Lockout Device		
	Lockout, 200 Amp 3- and 4-Pole Models	PTLOCK2004
	Lockout, 400 Amp 4-Pole Models	PTLOCK4004
Optional Accessory for Wire Size #1 to #4		
<i>Check National Electrical Code for proper wire size and application.</i>		
	200 Amp, 3-Pole Wire Adapter Kit	PTK200WA3
	200 Amp, 4-Pole Wire Adapter Kit	PTK200WA4
400 Amp Pressure Terminal Kits		
	Use with 400-500 MCM Wire ①	
	0.84" I.D. Wire Recess	
	3 Adapters	PTK84-3P
	4 Adapters	PTK84-4P
	Use With 750 MCM General Wire or 500-777 MCM Flexible Wire	
	1.18" I.D. Wire Recess	
	3 Adapters	PTK750-3P
	4 Adapters	PTK750-4P

① PTK84 pressure terminal kits for use with 400-500 MCM wire are NOT UL listed.



Powerite™ 200 and 400 Amp Replacement Parts

600 Vac, 250 Vdc, 50-400 Hz.

NEC/CEC – 200 Amp:
Listed for Ordinary (Unclassified) Locations
NEMA 3, 4, 4X

NEC/CEC – 400 Amp:
Listed for Ordinary (Unclassified) Locations
NEMA 4 – Optional

PLUGS AND RECEPTACLES: NEC/CEC ORDINARY LOCATION

	Description	Catalog Number
<p>NEMA 4X Plug Dust Cap</p> 	<p>Double sided plug dust cap for 3- and 4-Pole Models to keep plugs free of debris, moisture, and corrosion when not in use.</p>	<p>ACPCAP200</p>
<p>Plug Lockout Lanyard (Lockout Hasp Not Included)</p> 	<p>Adjustable lanyard with a lockout plate for padlocking devices. Used in conjunction with lockout slot on the plug sleeve provides an easy access lockout/tagout point to comply with OSHA 1910.147 standard.</p>	<p>PLGLOCK200</p>

APPLETON™

Powerlite™ 200 Amp Mounted Receptacle

600 Vac, 250 Vdc, 50-400 Hz.

NEC/CEC:
Listed for Ordinary (Unclassified) Locations
NEMA 3, 4, 4X

Dimensions in Millimeters (Inches)

Receptacle Mounted on AJA and AJAC Boxes

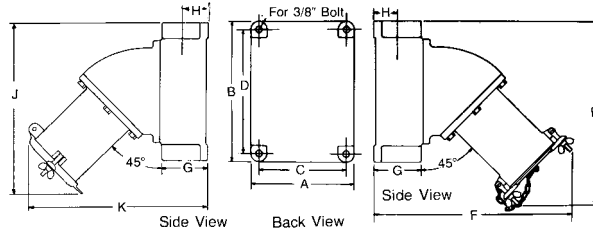

Dimensions in Millimeters (Inches)

A	B	C	D	E	F	G	H	J	K
203.2 (8.00)	273.0 (10.75)	171.4 (6.75)	241.3 (9.50)	355.6 (14.00)	387.3 (15.25)	95.2 (3.75)	47.7 (1.88)	342.9 (13.50)	361.9 (14.25)

Receptacle

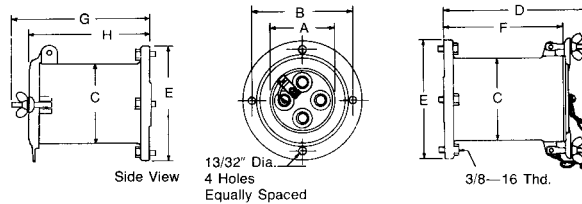

Dimensions in Millimeters (Inches)

No. Poles	A	B	C	D	E	F	G	H
3	82.5 (3.25)	143.0 (5.63)	10.46 (4.19)	203.2 (8.00)	168.4 (6.63)	166.6 (6.56)	170.1 (6.70)	179.0 (7.05)
4	92.2 (3.63)	143.0 (5.63)	115.8 (4.56)	203.2 (8.00)	168.4 (6.63)	166.6 (6.56)	170.1 (6.70)	179.0 (7.05)

PLUGS AND RECEPTACLES: NEC/CEC ORDINARY LOCATION

APPLETON™

Powertite™ 200 Amp Connector, Plug and Adapter

600 Vac, 250 Vdc, 50-400 Hz.

NEC/CEC:
Listed for Ordinary (Unclassified) Locations
NEMA 3, 4, 4X

PLUGS AND RECEPTACLES: NEC/CEC ORDINARY LOCATION

APPLETON™

Dimensions in Millimeters (Inches)

Connector Body

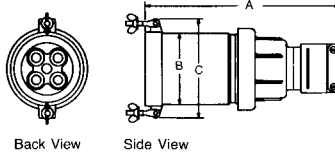

No. Poles	Dimensions in Millimeters (Inches)		
	A	B	C
3	330.2 (13.00)	106.4 (4.19)	136.6 (5.38)
4	330.2 (13.00)	115.8 (4.56)	146.0 (5.75)

Plug

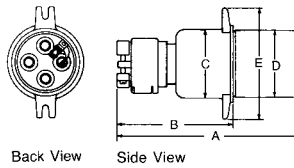

No. Poles	Dimensions in Millimeters (Inches)				
	A	B	C	D	E
3	327.7 (12.9)	223.5 (8.8)	96.5 (3.8)	96.5 (3.8)	162.6 (6.4)
4	327.7 (12.9)	223.5 (8.8)	106.7 (4.2)	104.1 (4.1)	172.7 (6.8)

AJA200 Angle Adapter

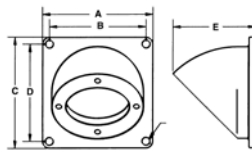

Dimensions in Millimeters (Inches)				
A	B	C	D	E
203.2 (8.0)	177.8 (7.0)	203.2 (8.0)	177.8 (7.0)	152.4 (6.0)

Powerlite™ 400 Amp Mounted Receptacle and Receptacle

600 Vac, 250 Vdc, 50-400 Hz.

NEC/CEC:
Listed for Ordinary (Unclassified) Locations
NEMA 4 – Optional

Dimensions in Millimeters (Inches)

Receptacle Mounted on AJAC Box

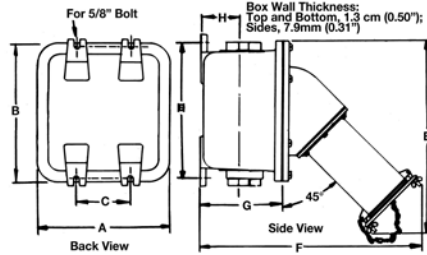

Hub Size ①	Dimensions in Millimeters (Inches)							
	A	B	C	D	E	F	G	H
4.00/10.16	403.3 (15.88)	403.3 (15.88)	165.1 (6.50)	384.3 (15.13)	558.8 (22.00)	615.9 (24.25)	215.9 (8.50)	98.5 (3.88)

Receptacle

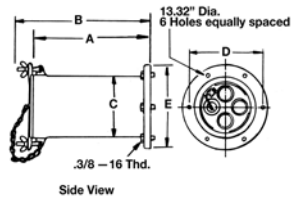

No. Poles	Dimensions in Millimeters (Inches)					
	A	B	C	D	E	F
3	285.7 (11.25)	311.1 (12.25)	130.3 (5.13)	171.4 (6.75)	196.8 (7.75)	106.4 (4.19)
4	285.7 (11.25)	311.1 (12.25)	143.0 (5.63)	171.4 (6.75)	196.8 (7.75)	119.1 (4.69)

① AJAC box has feed-thru 101.6 mm (4") openings. Supplied with one 101.6 mm (4") to 76.2 mm (3") reducer, and one 101.6 mm (4") close-up plug.

Powertite™ 400 Amp Connector and Plug

600 Vac, 250 Vdc, 50-400 Hz.

NEC/CEC:
Listed for Ordinary (Unclassified) Locations
NEMA 4 – Optional

Dimensions in Millimeters (Inches)

Plug

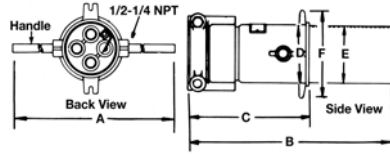

No. Poles	Dimensions in Millimeters (Inches)					
	A	B	C	D	E	F
3	381.0 (15.00)	482.6 (19.00)	285.7 (11.25)	119.3 (4.70)	118.3 (4.66)	190.5 (7.50)
4	393.7 (15.50)	482.6 (19.00)	285.7 (11.25)	131.8 (5.19)	131.0 (5.16)	203.2 (8.00)

Connector Body

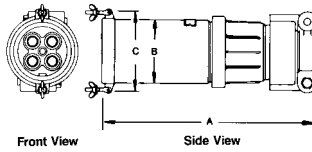

No. Poles	Dimensions in Millimeters (Inches)		
	A	B	C
3	482.6 (19.00)	130.3 (5.13)	184.1 (7.25)
4	482.6 (19.00)	143.0 (5.63)	196.8 (7.75)

PLUGS AND RECEPTACLES: NEC/CEC ORDINARY LOCATION

APPLETON™